

## **WARNING**

### **EXTREME CARE MUST BE USED FOR YOUR SAFETY**

#### **PLANNING**

Plan your installation carefully. If you use volunteer helpers be sure that they are qualified to assist you. Make certain that everyone involved understands that you are the boss and that they must follow your instructions. If you have any doubts at all, employ a professional antenna installation company to install your antenna.

#### **POWER LINES**

This antenna is an electrical conductor. Contact with power lines can result in death, or serious injury. Do not install this antenna where there is any possibility of contact with or high voltage arc over from power cables or service drops to buildings. The antenna, supporting mast and/or tower must not be close to any power lines during installation, removal or in the event part of the system should accidentally fall. Follow the guidelines for antenna installations recommended by the U.S. Consumer Product Safety Commission.

#### **CONTACT WITH ANTENNA AND RF**

You must insure that while the hexagonal beam is in operation neither people or pets can come in contact with any portion of your antenna. Deadly voltages and currents may exist. Also, since the effects of exposure to RF fields are not fully understood, long term exposure to intense RF fields is not recommended.

#### **SYSTEM GROUNDING**

Direct grounding of the antenna mast and tower is very important. This serves as protection from lightning strikes and static buildup, and from high voltage which is present in the radio equipment connected to the antenna. A good electrical connection should be made to one or more ground rods (or other extensive ground system) directly at the base of the tower or mast, using at least #10AWG ground wire and noncorrosive hardware. For details and safety standards, consult the National Electrical Code. You should also use a coaxial lightning arrester.

For the safety of users, this pamphlet is provided with every hex beam  
sold by KIO Technology LLC.



## KIO Hex Beam

Assembly Instructions v 10.0  
January 2021

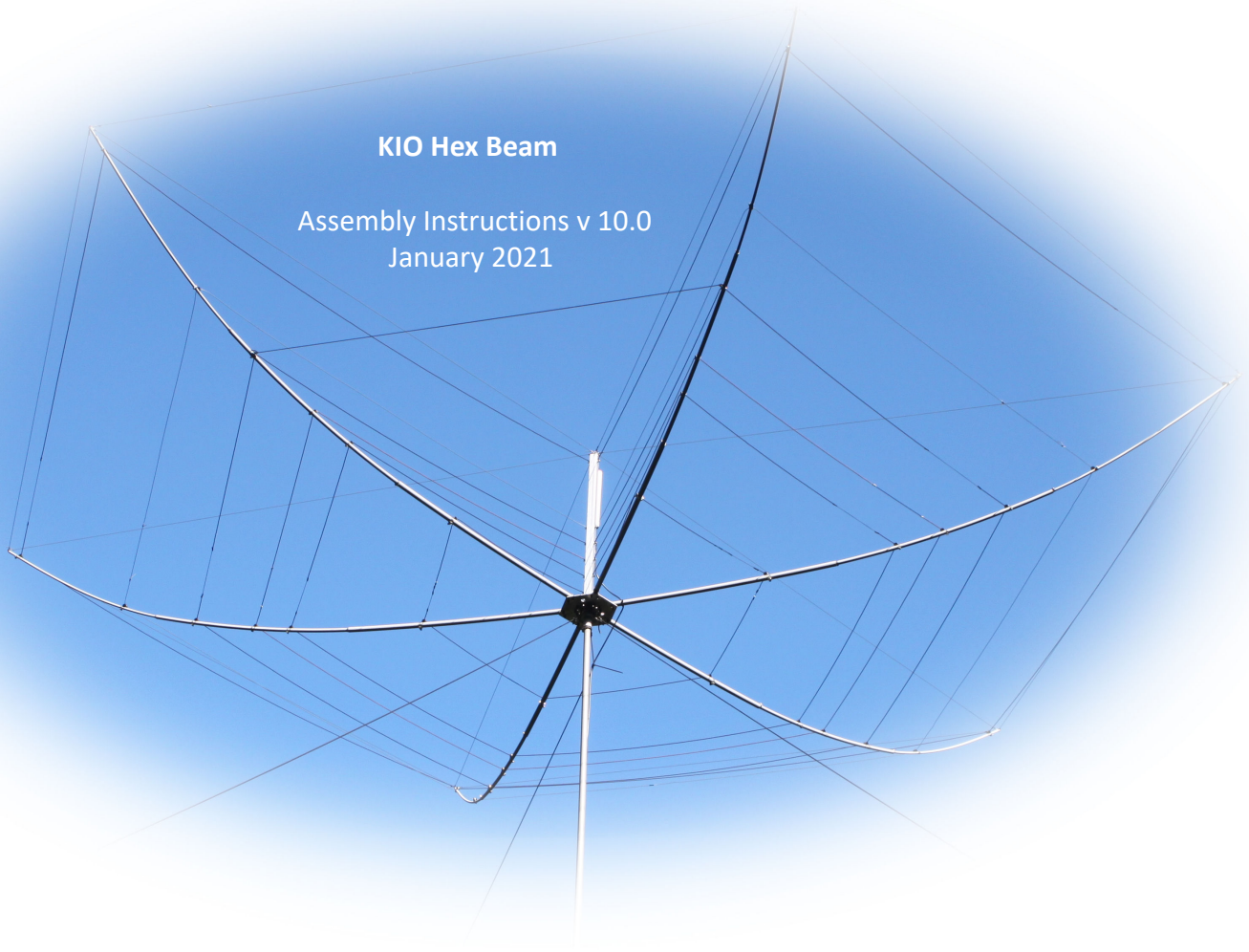

**Introduction:**

You have purchased a G3TXQ broad band hex beam built by KIO Technology. This beam can be assembled in an evening with only a few hand tools. All wires have been measured, cut and no tuning is needed to have great performance. You need little technical expertise to assemble this beam. You do need a license from the FCC to transmit with it in the USA.

**Tools Needed:**

- Med. Screwdriver for spreader clamps
- Pliers for closing S hooks on support cords
- End wrench for the U bolt nuts
- 3/16 " Allen wrench (supplied)
- gloves

**Components Included:**

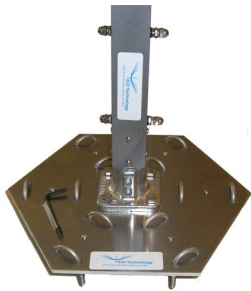

Base plate equipped with one top flange, one mast bracket with U bolts and 12 stainless steel spreader arm U-bolts.

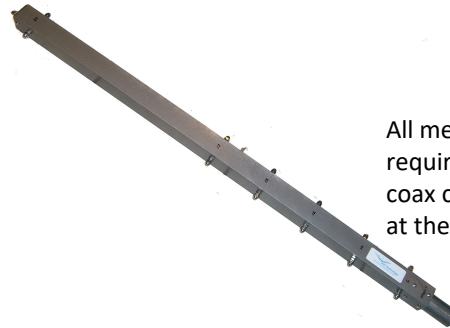

All metal, coaxial aluminum center post that requires no wiring harness. An SO 239 UHF coax chassis socket is on the back of the post at the top.



Six fiberglass spreader arms of three telescoping sections for each. Equipped with cushioned wire guides for attaching wire sets.



Wire/tip space assemblies separately bagged and labeled for each band. Wires and tip spacers are pre-measured and assembled, ready for installation on the hexagonal frame. The wire is pvc insulated #14 168 strand Flex weave.



Seven Kevlar/Dacron covered support cords (all the same size) with stainless steel end hooks installed and one smaller intermediate cord with clamps. Clamps for securing the hooks to the spreader arms are included.

**Assembly:**

Step 1. Base plate

Install the bottom bracket with its U-bolts to the bottom of the base plate using the two loose bolts in the bracket and the two holes marked on the bottom of the base plate. The bracket can be installed later if you want to set the beam on a flat table while assembling it.

**Step 2 Prepare Spreader Arms** *(Use gloves in handling these spreaders to avoid fiberglass residue)*

Before assembly of the hex beam, the spreader arms must be prepared. This consists of painting the fiberglass tubes and installing the wire guides. The locations of the wire guides will probably need to be adjusted slightly in Step 6 after the wires have been installed to get the tension of the wires right

Because fiberglass is vulnerable to ultraviolet rays emitted by the sun, a coat of paint is needed to protect the tubes. Failure to paint the tubes will eventually result in flaking on the surface. The duration and intensity of sunlight determines how fast this effect takes place. Painting can be elaborate with primer and several coats but generally, a single coat of paint/primer combined is all that is needed. We recommend Rustoleum spray paint/primer for the painting. Two cans are easily enough for one hex beam. Or you can use a paint brush and a single coat of exterior latex instead. Flat black is a good color for stealth but any color of your own choice may be used.

The six spreader arms consist of three fiberglass tubes (each) that have wire guides installed and will telescope into each other. All three sections of only one spreader arm are completely assembled with both the stop clamps and the wire guides for the band(s) you ordered. This one spreader arm should be used as a guide for installation of the stop clamps and wire guides of the other five arms when they have been painted and dried.

- A. Wipe the dust off all the fiberglass tubes except the sections that have the wire guides installed and apply the paint.
- B. When dry, lay each section of the sixth arm which has the wire guides installed alongside each of the five painted sections and install the wire guides for that section on all five arms. Use the dressed fiberglass tubes as guides for installing the wire guides. If it is needed, a sketch showing the initial locations of the wires guides can be downloaded from the support page of our web site at [www.k4kio.com](http://www.k4kio.com).
- C. Then remove the stop clamp and the wire guides on the three sections of the sixth arm and paint them. Only wire guides for the bands you ordered will be included.

Application of too much paint on the telescoping ends of the tubes can make it difficult to fit them together. Therefore, some care is needed here. Avoid painting the telescoping ends if brushing. If spraying, use masking tape to cover the few inches of the telescoping end before spraying.

- D. When dry, the sixth arm should be re-assembled and you are ready to proceed with Step 3 of the assembly instructions (Page 5).

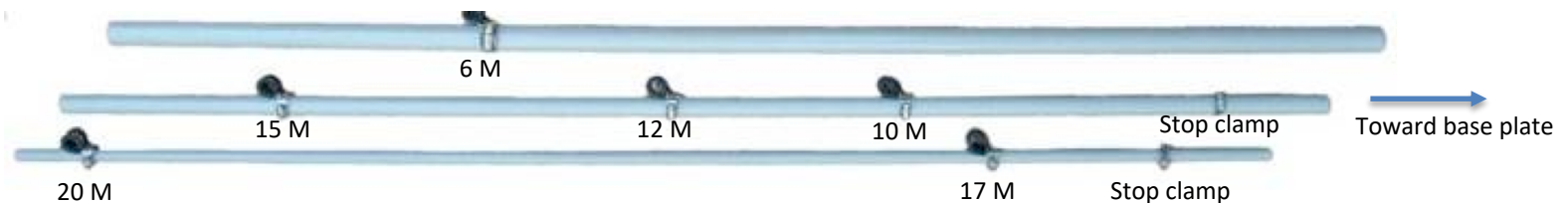



### Step 3. Install the Spreaders Arms

A. Insert the six large spreader sections (1 inch thick) into the U-bolts on the base plate. All these six spreader sections are identical.

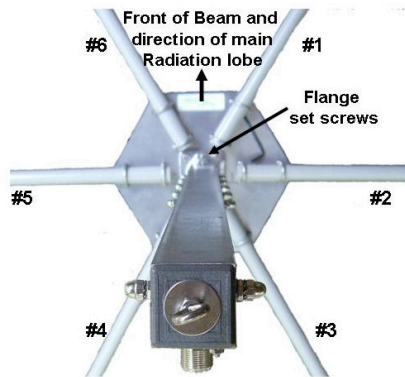

B. Tighten the U bolt nuts on the bottom of the base plate but be careful not to over tighten as you might crush the spreaders. If you see the spreader being flattened against the base plate, you are tightening it too much.

**Tip: (Look across the beam to see if a spreader is lined up with its opposite. If not, then re-adjust the nuts on the U bolts to make them more even.**

C. Arrange a temporary stand for assembling the rest of the beam. A large 10 gallon paint bucket turned right side up, with bricks, sand or other weights in it that you can set the beam on will work or a 3/4 inch pipe stuck in the ground. You will want the spreaders to be fairly level as you install the wire/tip space assemblies. Of course you can use a table if the bottom bracket has not been installed.

D. Insert each of the six medium spreader sections (3/4 inch thick) into the end of a larger spreader and push it up to the stop clamp on the medium spreader. When pushing the sections together be sure the P clips are on the upper side of the spreaders.

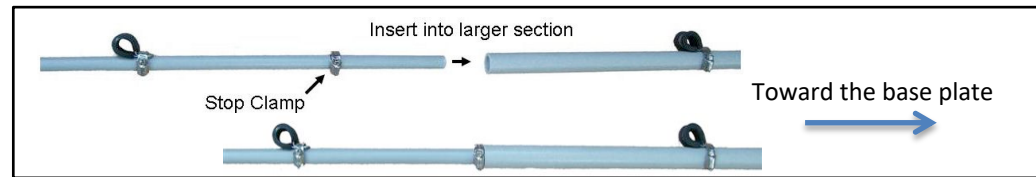

E. Insert each of the six small spreader sections (1/2 inch thick) into the end of a medium spreader and push up to the stop clamp.

F. The spreader sections will be kept together by the tension of the support cords and can be easily taken apart for portability. However, if you wish, you can attach them permanently by the use of general purpose adhesive such as Liquid Nail. Or you can drill a small hole through the ends that are telescoped and use a small #6 machine bolt. But neither is necessary for the beam to hold together adequately.

#### Step 4. Install the Center post

Insert the center post into the base plate and turn it so that the white KIO logo label on the post is toward the KIO logo label on the base plate. This is the front of the beam and the direction of the main beam lobe. The coax will connect on the back of the center post and come down the back of the center post and over the back edge of the base plate. Tighten the set screws on the flange using the 3/16" hex key supplied. Do not over tighten the center post.

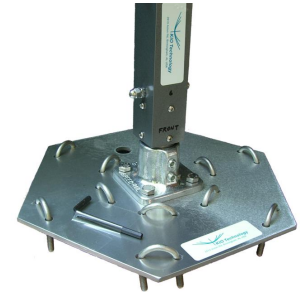

#### Step 5. Install the Support Cords

A. Hook a support cord to the end of a spreader and pull it toward the center post and let it lie on the ground loose.

B. Hook another support cord to the end of the opposite spreader from Step 5.A. and pull it toward the center post.

C. Now grip the loose ends of both support cords and pull them together until you can hook both over the eye bolt on the top of the center post at the same time. The idea of pulling two spreaders up at the same time is to avoid unnecessary stress on the center post.

D. Repeat this with another pair of spreaders and support cords and then again until all six spreaders and support cords are attached to the center post.

E. There are two remaining support cords. Hook the larger one between the ends of spreaders 1 and 6. The remaining small support cord will be attached later in Step 6 J. after the wires have been installed. Dashed lines at right show the cords. The purpose of these two cords is to pull the spreaders arms 1 and 6 back into position.

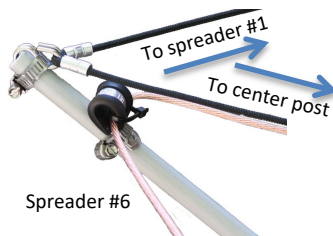
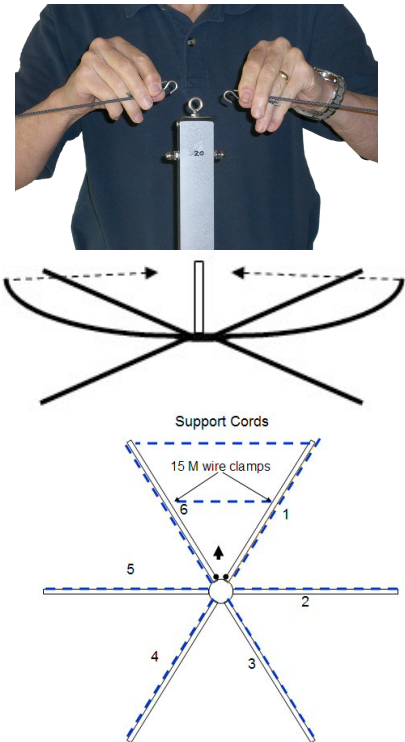

Spreader arms 1 and 6 are usually pulled too far apart by the weight and tension of the wires. When you first install this perimeter cord it will likely be too slack but it will tighten up later when the wires are installed.

F. Fasten the hooks on the ends of the spreaders with the clamps supplied as shown to the left.

G. With pliers, squeeze all the hooks closed on the post top ring. You now have the basic hexagonal beam shape established.

Step 6. Install the Wire/Tip Spacer Assemblies

A. **Do not over tighten the wires.** The wires should be a little slack. It is not necessary for the wires to be taut for the beam to perform as it is supposed to perform.

B. Begin with the 6 meter Wire/Tip Spacer assembly (or the highest frequency band provided) and repeat for each of the bands with the lowest frequency band last. The lowest band will be the longest wire assembly. The wire/tip spacer assemblies are already adjusted exactly for each band and no adjustment of their length is required.

**Tip:** To keep it from getting tangled up lay the wire assembly out along the ground unraveled and then start threading it through the wire guides carefully starting with spreader No 1.

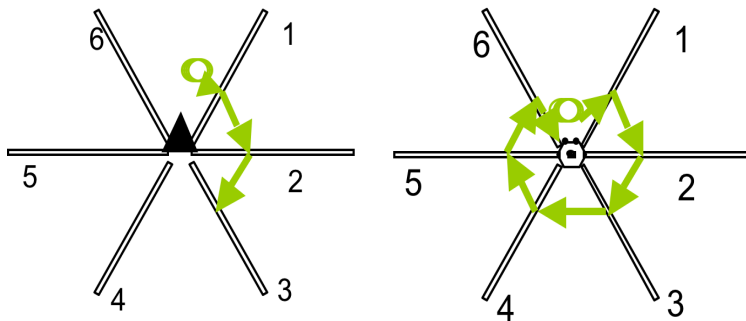

C. The 6 meter wire assembly (or the highest frequency band ordered) uses the wire guides nearest the center post attachments.

D. When the assembly is pulled through the clamp attachments around all six spreaders you are ready to connect each of the two ends to the two terminals on opposite sides of the post marked 10.

E. Pull the ends with the lugs in toward the center post and connect them to the bottom terminal. One end of the wire set connects to one side of the center post for that particular band and the other end of the wire set connects to the other side of the center post for that particular band. Use the nuts supplied in the small bag attached to the center post to fasten the wire lugs to the terminal posts.

If there is not enough slack to get the wire lugs on the terminals just loosen the wire guides on Spreaders 1 and 6 and let them slip in toward the center post to allow you to make the terminal connections. When tightening the nuts be careful not to allow the bolt itself to twist. Use a small wrench or pliers to hold the hex nut while tightening the nut as shown at right. Do not over tighten; just get it snug.

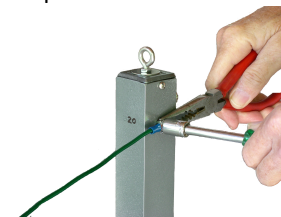

The wire/tip spacer assembly looks like this when viewed from above after being installed on the frame.

20 Meter Broadband Hex Wires and Spacers (pvc ins.)  
Top View, Spreaders are not shown

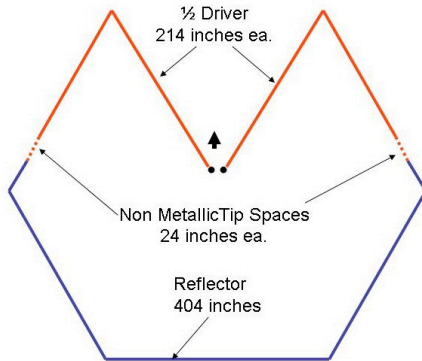

F. Repeat this process for all the other bands until all wire assemblies are installed.

G. Now begin re-adjusting the wire guides that were loosened to allow you to connect the wires to the terminals. **Do not over tighten the wires** as this will distort the beam shape.

H. When complete, look at the wires to see if any are too taut or loose. Care should be taken to avoid a wire drooping down close to the wire below. This is especially important in the spans from the center post out to the ends of spreaders 1 and 6. The sketch below illustrates this idea. If any wires are drooping you can take up the slack by moving wire guides outward for that wire. If you need to move any wire guides for a band, move them by small amounts, say 1/4 inch, until you are satisfied.

I. Remember, having taut wires might look better but it will not improve beam performance. It is better to have the wires just a slight bit slack than too tight as this reduces stretching of the wires and unnecessary tension on the wire/tip spacer joints.

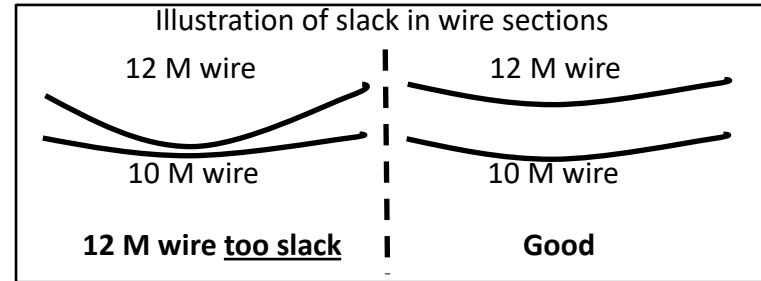

J. Use the remaining small support cord to attach with the clamps to Spreaders 1 and 6 to pull them back into shape. This cord should be located at about the 15 meter wire but put it where it seems to do the most good in pulling the spreaders back straight.

K. Conduct a DC continuity test from the center of the SO 239 socket to the bottom insulated terminal on the center post. You should have zero DC resistance. Also check across the center of the socket to the outside of the socket to be sure there is no short anywhere. Of course, the transmission line should not be connected for these tests. You should use coax seal when making the final connection of your transmission line to the hexagonal beam to keep moisture from contaminating the coax line. You can route your coax cable over the edge of the base plate.

We do not recommend the use of right angle PL259 connectors to connect your coax cable to the center post as these have been found to cause intermittent connections over time and ruin the performance of the hex beam. These connectors are poorly designed inside.

You are finished assembling the KIO hex beam. Now, a few simple tests are needed before lifting it onto your mast.

## SWR tests:

**It is very important to check the beam out for SWR before elevating the beam to its final position on a tower or mast.** If you do not have a test set, the internal SWR indicator in your transceiver can be used although generally these are not as accurate as test sets. Just connect the beam to the transceiver and be careful. Power applied to the beam results in harmful voltage levels on the terminals so use low power for tests with the transceiver. You should remember that SWR depends on the height of the beam above ground. Normally, on the test stand a few feet above ground, you should be able to see a dip in SWR for each band and the lowest point will be probably in the 2-3:1 range. When you elevate the beam to the operating height, hopefully at least 20 feet, you should see much better SWR across all bands.

## Troubleshooting:

If you cannot get SWR readings that are in the 2-3:1 range on the test stand, check the following:

- All wires are snugly connected to their terminals.
- The test set is connected properly to the hex beam with a PL 259 type coax connector. Make sure you have a good test set.
- Make sure all wire assemblies are properly strung on the spreaders, none should be touching each other. Don't look for minor assembly issues like uneven spreaders or the like. You don't have to have a perfect looking beam for it to work just fine. The wires are the main thing.

## Use of a common mode choke balun:

When an unbalanced feed line such as coax feeds a balanced antenna such as a hex beam, common mode currents will flow on the outside of the coax. This effectively creates radiation causing a distortion in the antenna's radiation pattern. You might have this and be unaware of it as the SWR is frequently unaffected. The easiest way to combat this is to use a 1:1 common mode choke balun such as the ones we offer. This balun can be located just below the SO 239 coax connector at the top of the center post or below the base plate. Other 1:1 baluns such as those sold by MFJ or DX Engineering are quite acceptable as well.

## CAUTION:

This beam is rated for 2000 watts. Running power in excess of this or operating the beam on bands not equipped on your beam can cause excessive voltage and arcing of the terminals on the center post. Operating in such a manner voids the warranty and parts damaged in so doing are replaceable at full cost including shipping, to the user.

## Other Rotator and tower considerations:

A steel push up mast is used by many beam owners to support the hex beam. However, you will need to guy it properly. Proper safety measures should be observed if using a tower.

Attach the coax transmission line to one of the spreaders about 1 – 2 feet out from the center using a cable tie to allow it to rotate with the beam and avoid tension on the coax connector on the center post. Allow a couple feet of slack below the baseplate to allow the antenna to turn freely.

Unless you selected the Universal Mast Clamp, the mast fixture for you to install on the bottom of the base plate will look like the Standard mast photo on the left. Both fixtures are installed using the four bolts in the middle of the baseplate. Assemble the mast fixture according to the instructions provided with the fixture. If you are using the Standard mast fixture, be sure and drill a hole through the mast and insert the hex pinning bolt to keep the beam from slipping on the mast when you are ready to install the beam.

If the Universal mast fixture is used, a pinning bolt is not needed. The Universal fixture will accommodate masts that are 1 ¼ - 2 ½ inches in diameter.

#### Your Tower

By now you should already have determined the structure for supporting your new hex beam. If not, spend some time studying our gallery of actual installations which show a variety of arrangements at [www.k4kio.com](http://www.k4kio.com). There is not a cookie cutter solution to the issue of supporting your hexagonal beam but a little study can help you settle on one that suits your circumstances.

Standard Push up Mast Bracket

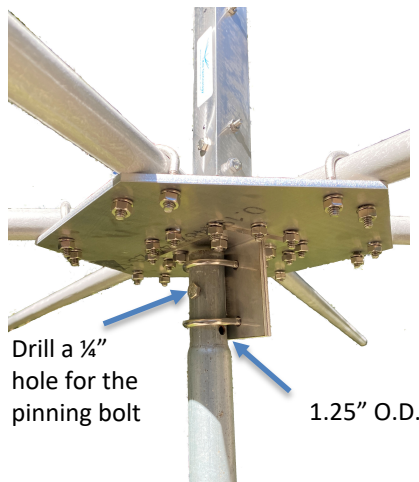

Universal Mast Clamp

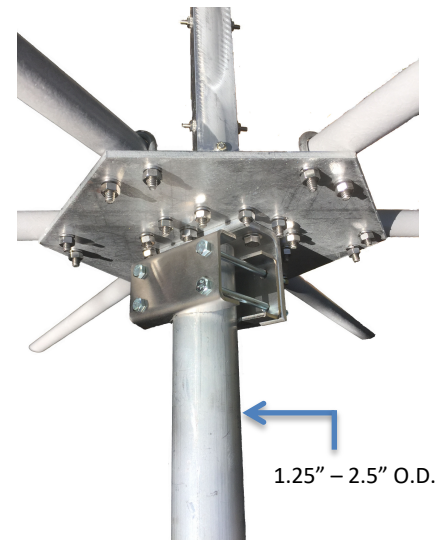

#### Wire/Tip Spacer lengths (inches)

Band	½ Driver wire	Reflector wire	Tip Spacers
20	214.0	404.0	24.0
17	166.0	314.5	18.5
15	142.9	271.8	16.0
12	119.25	227.25	13.5
10	104.5	200.25	12.0
6	59.0	113.4	6.5

Weight	26 - 29lbs (depending on number of bands)
Diameter	21 ft.
Ht.	38 inches
Wind Surface Area	5 sq. ft.
SWR	< 2.0:1 (except on the upper range of 10 M)
Forward Gain, maximum	5 dBi
Front/Back ratio, min.	10 dB